

RPower OGiV12400LP (12V 40Ah AGM Battery)

Floating Life at 20°C designed for 10-12 years

EAN: 4260349823357

Dimensions

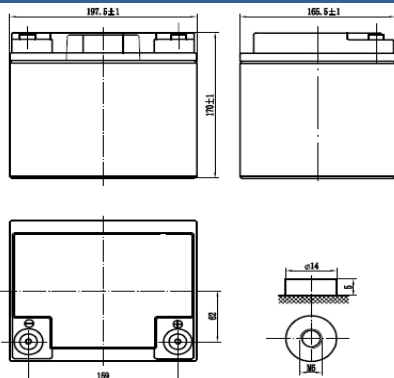

Specifications

Nominal Voltage		12V
Capacity (10hr@25°C@1.75V/C)		40Ah
Dimensions	Length	197mm (7.76inch)
	Width	165mm (6.50inch)
	Height	170mm (6.69inch)
	Total Height	170mm (6.69inch)
Approx. Weight		13.80kg (30.42lbs)
Maximum charging current		12.0A
Maximum discharge current		400A (5sec.)
Internal resistance		Approx. 9.7mΩ
Capacity affected by temperature (20hr)	40°C	103%
	25°C	100%
	0°C	86%
	-15°C	65%
Self-discharge (25°C)	3 month	Remaining Capacity: 91%
	6 month	Remaining Capacity: 82%
	12 month	Remaining Capacity: 65%
Nominal operating temperature		25°C ±3°C (77°F±5°F)
Operating temperature range		-20°C~55°C (-4°F~131°F)
Float charging voltage (25°C)		13.65 to 13.80V
Cyclic charging voltage (25°C)		14.40 to 15.00V
Terminal material		Copper

The Relationship for Charging Voltage and Temperature

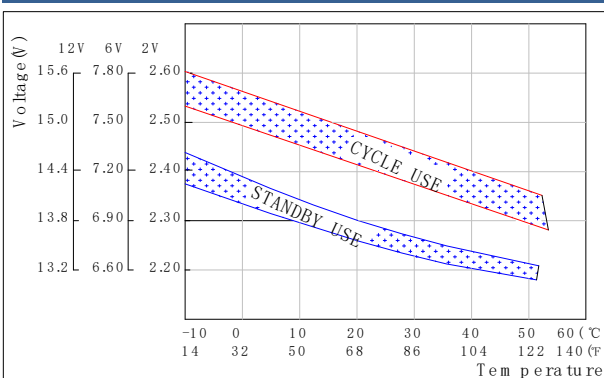

Charging Characteristics (25°C)

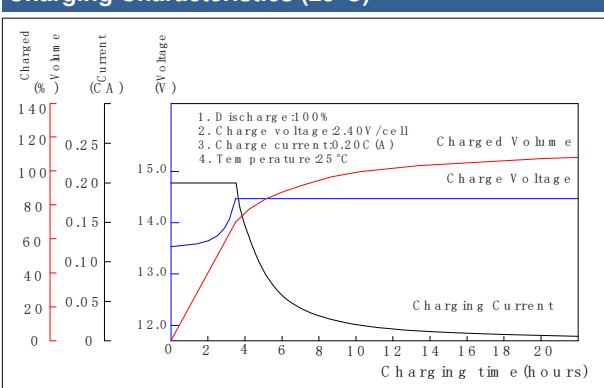

Discharge Characteristics (25°C)

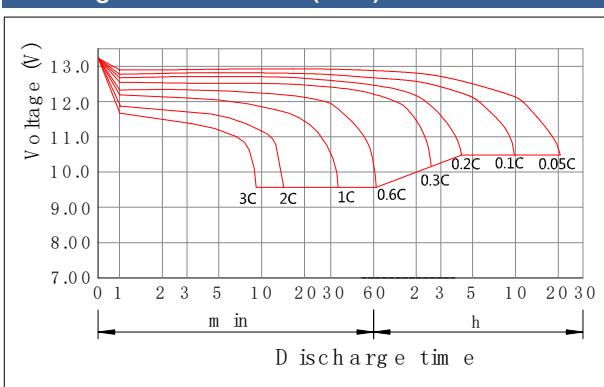

Constant Current Discharge Characteristics (Ampere / Battery, 25°C)

FV / TIME	5min	10min	15min	20min	30min	45min	1h	2h	3h	4h	5h	6h	8h	10h	20h
10.98V	90,11	67,80	53,54	42,20	34,73	25,32	22,80	12,61	9,15	7,61	6,46	5,33	4,04	3,82	2,05
10.80V	92,90	69,90	55,20	43,50	35,80	26,10	23,50	13,00	9,43	7,85	6,66	5,49	4,16	3,94	2,11
10.50V	101,00	73,60	61,00	51,40	36,10	26,40	23,90	13,30	9,65	8,04	6,83	5,64	4,27	4,00	2,15
10.20V	109,00	77,80	64,50	54,20	37,30	26,70	24,20	13,60	9,89	8,23	6,97	5,73	4,31	4,05	2,18
9.90V	119,00	82,20	67,10	55,00	38,70	28,00	24,60	13,90	10,10	8,40	7,10	5,82	4,35	4,10	2,20
9.60V	127,00	86,50	70,70	57,90	39,90	28,30	24,90	14,20	10,30	8,56	7,22	5,90	4,39	4,15	2,22

Constant Power Discharge Characteristics (Watt / Battery, 25°C)

FV / TIME	5min	10min	15min	20min	30min	45min	1h	2h	3h	4h	5h	6h	8h	10h	20h
10.98V	995,22	756,60	634,38	491,21	414,97	322,43	271,79	155,98	114,07	88,46	77,41	62,27	46,97	44,46	23,80
10.80V	1026,00	780,00	654,00	506,40	427,80	332,40	280,20	160,80	117,60	91,20	79,80	64,20	48,42	45,84	24,54
10.50V	1092,00	828,00	678,00	530,40	442,80	339,60	285,00	164,40	120,00	93,60	80,40	65,40	49,68	46,56	25,02
10.20V	1188,00	864,00	702,00	530,60	457,80	346,80	289,80	168,00	121,80	96,00	81,60	66,60	50,16	47,16	25,38
9.90V	1284,00	912,00	720,00	540,20	472,80	354,00	295,20	171,60	124,20	97,80	82,80	67,80	50,64	47,70	25,62
9.60V	1380,00	948,00	744,00	573,80	487,20	361,20	299,40	175,80	126,00	99,60	84,00	68,40	51,12	48,30	25,86